

# KSEM2850FEGM KCPM45 FLAT BOTTOM

Produktnummer: 5981596



## Spesifikasjoner

Vekt	0.042 kg
Bredde/tykkelse	0.0 mm
Høyde	0.0 mm
Volum	0.02 liter
Dimensjon	0.0
Nøkkelvidde	0.0 mm
Form	FEG
kW	0.0
Innvendig diameter	0.0 mm
Utvendig diameter	0.0 mm
Type	0
Type 4	0.0
Delelengde	0.0 mm
Type 3	0.0
Bredde ytre ring	0.0 mm
Bredde indre ring	0.0 mm
Type 2	0.0
Type 5	0.0
Bordiameter	28.5 mm

<b>Bortype</b>	0
<b>Diameter</b>	0.0 mm
<b>Neseradius</b>	0.0 mm
<b>Antall tenner/rader/deling/spor</b>	0
<b>Lengde</b>	0.0 mm

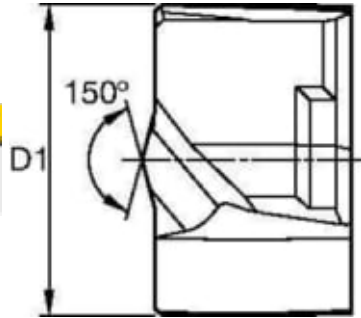
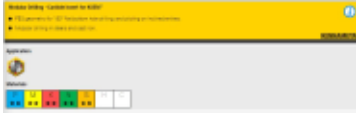

Les mer om produktet her:

<https://www.ail.no/product?number=5981596>